



HANDBOOK OF CONTROL VALVE

SIZING



SHANGHAI THINKTANK PROCESS MANAGEMENT CO., LTD

Dept. of Foreign Trade: #407 Rongxing Road, Songjiang District, Shanghai City.
Factory1: #1 Jiaoxia Industrial Zone, Wenzhou City.

<https://cncontrolvalve.com>

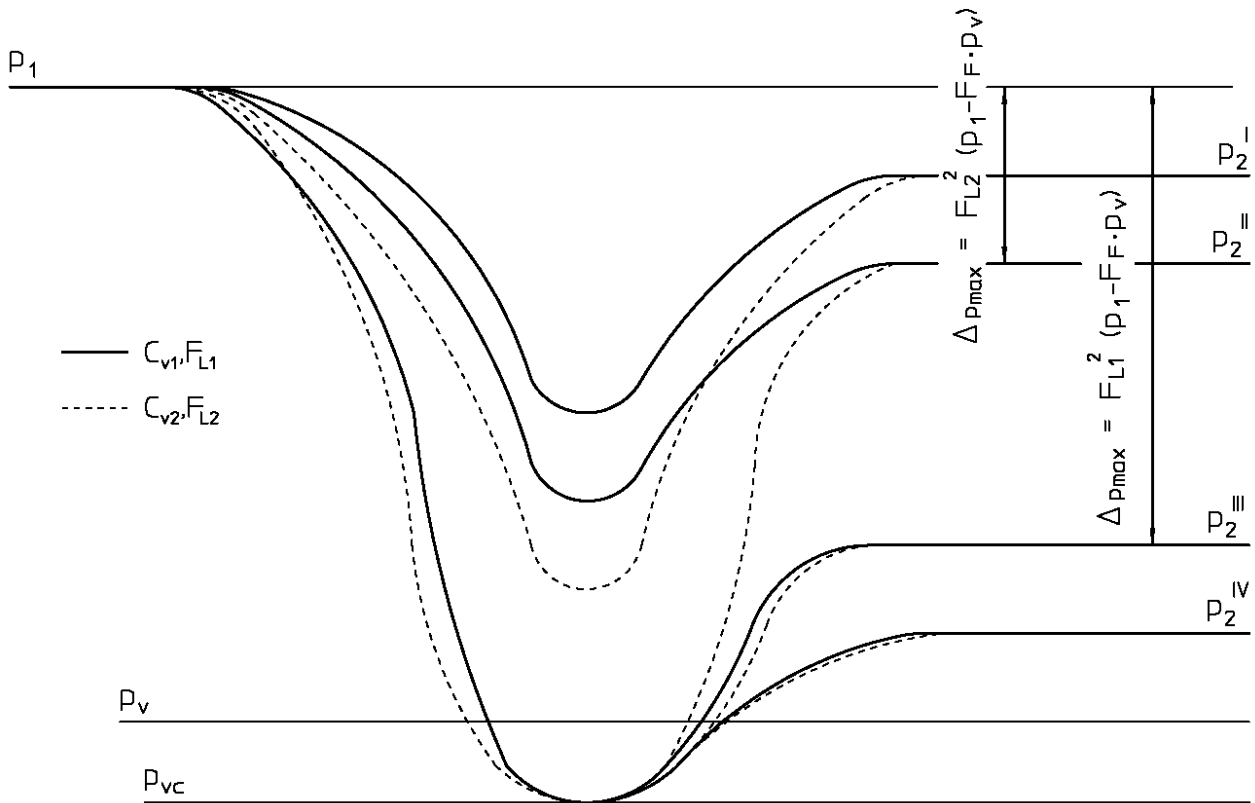
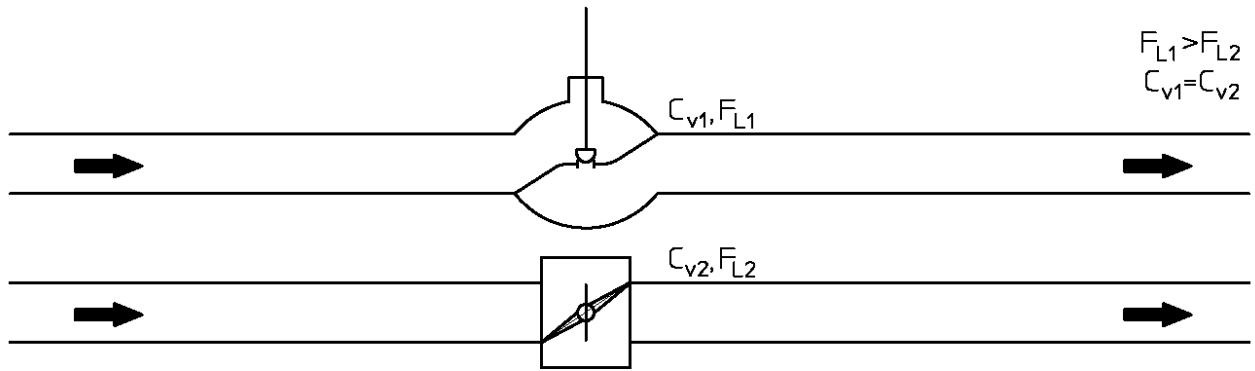

HANDBOOK FOR CONTROL VALVE SIZING

NOMENCLATURE

SIZING AND SELECTION OF CONTROL VALVES

0 NORMATIVE REFERENCES

1 PROCESS DATA

2 VALVE SPECIFICATION

3 FLOW COEFFICIENT

- 3.1 Flow coefficient K_V (metric units)
- 3.2 Flow coefficient C_V (imperial units)
- 3.3 Standard test conditions

4 SIZING EQUATIONS

- 4.1 Sizing equations for incompressible fluids (turbulent flow)
- 4.2 Sizing equations for compressible fluids (turbulent flow)
- 4.3 Sizing equations for two-phase flows
- 4.4 Sizing equations for non-turbulent flow

5 PARAMETERS OF SIZING EQUATIONS

- 5.1 Liquid pressure recovery factor F_L
- 5.2 Coefficient of incipient cavitation x_{FZ} and coefficient of constant cavitation K_C
- 5.3 Piping geometry factor F_P
- 5.4 Combined liquid pressure recovery factor and piping geometry factor of a control valve with attached fittings F_{LP}
- 5.5 Liquid critical pressure ratio factor F_F
- 5.6 Expansion factor Y and specific heat ratio factor F_γ
- 5.7 Pressure differential ratio factor x_T
- 5.8 Pressure differential ratio factor for a valve with attached fittings x_{TP}
- 5.9 Reynolds number factor F_R
- 5.10 Valve style modifier F_d



NOMENCLATURE

Symbol	Description	Units (notes)
A	flow passage area at the actual valve stroke	mm ²
C _v	flow coefficient	U.S. gallons/min
d	nominal valve size	mm
D	internal diameter of piping	mm
d _o	equivalent circular flow passage diameter	mm
d _H	hydraulic diameter of a single flow passage	mm
F _d	valve style modifier	dimensionless
F _F	liquid critical pressure ratio factor	dimensionless
F _L	liquid pressure recovery factor for a control valve without attached fittings	dimensionless
F _{LP}	combined liquid pressure recovery factor and piping geometry factor of a control valve with attached fittings	dimensionless
F _P	piping geometry factor	dimensionless
F _R	Reynolds number factor	dimensionless
F _γ	specific heat ratio factor = $\gamma / 1.4$	dimensionless
K _{B1} and K _{B2}	Bernoulli coefficients for inlet and outlet of a valve with attached reducers	dimensionless
K _c	coefficient of constant cavitation	dimensionless
K _v	flow coefficient	m ³ /h
K ₁ and K ₂	upstream and downstream resistance coefficients	dimensionless
M	molecular mass of the flowing fluid	kg/kmol
p _c	absolute thermodynamic critical pressure	bar absolute
p _v	absolute vapour pressure of the liquid at inlet temperature	bar absolute
p _{vc}	vena contracta absolute pressure	bar absolute
p ₁	inlet absolute pressure measured at upstream pressure tap	bar absolute
p ₂	outlet absolute pressure measured at downstream pressure tap	bar absolute
Δp	pressure differential between upstream and downstream pressures	bar
Δp _{max}	maximum allowable pressure differential for control valve sizing purposes for incompressible fluids	bar
P _w	wetted perimeter of flow passage	mm
q _m	mass flow rate	kg/h
q _v	volumetric flow rate	m ³ /h
q _{m(max)}	maximum mass flow rate in choked condition	kg/h
q _{v(max)}	maximum volumetric flow rate in choked condition	m ³ /h
Re _v	valve Reynolds number	dimensionless
T ₁	inlet absolute temperature	K
u	average fluid velocity	m/s
v	specific volume	m ³ /kg
x	ratio of pressure differential to inlet absolute pressure	dimensionless
x _{cr}	ratio of pressure differential to inlet absolute pressure in critical conditions ($\Delta p / p_1$) _{cr}	dimensionless
x _{FZ}	coefficient of incipient cavitation	dimensionless
x _T	pressure differential ratio factor in choked flow condition for a valve without attached fittings	dimensionless
x _{TP}	value of x _T for valve / fitting assembly	dimensionless
Y	expansion factor	dimensionless
Z	compressibility factor (ratio of ideal to actual inlet specific mass)	dimensionless
γ	specific heat ratio	dimensionless
ρ ₀	specific mass of water at 15.5 °C i.e. 999 kg/m ³	kg/m ³
ρ ₁	specific mass of fluid at p ₁ and T ₁	kg/m ³
ρ _r	ratio of specific mass of fluid in upstream condition to specific mass of water at 15.5 °C (ρ_1 / ρ_0)	dimensionless
ν	kinematic viscosity ($\nu = \mu / \rho$)	centistokes = 10 ⁻⁶ m ² /s
μ	dynamic viscosity	centipoises = 10 ⁻³ Pa·s

SIZING AND SELECTION OF CONTROL VALVES

The correct sizing and selection of a control valve must be based on the full knowledge of the process.

0. NORMATIVE REFERENCES

- IEC 60534-2-1, Industrial process control valves – Flow capacity – Sizing under installed conditions
- IEC 60534-2-3, Industrial process control valves – Flow capacity – Test procedures
- IEC 60534-7, Industrial process control valves – Control valve data sheet
- IEC 60534-8-2, Industrial process control valves – Noise considerations – Laboratory measurement of noise generated by hydrodynamic flow through control valves

1. PROCESS DATA

The following data should at least be known:

- a. Type of fluid and its chemical, physical and thermodynamic characteristics, such as:
 - pressure p ;
 - temperature T ;
 - vapour pressure p_v ;
 - thermodynamic critical pressure p_c ;
 - specific mass ρ ;
 - kinematic viscosity ν or dynamic viscosity μ ;
 - specific heat at constant pressure C_p , specific heat at constant volume C_v or specific heat ratio γ ;
 - molecular mass M ;
 - compressibility factor Z ;
 - ratio of vapour to its liquid (quality);
 - presence of solid particles;
 - flammability;
 - toxicity;
 - other.
- b. Maximum operating range of flow rate related to pressure and temperature of fluid at valve inlet and to differential pressure Δp across the valve.
- c. Operating conditions (normal, maximum, minimum, start-up, emergency, other).
- d. Ratio of pressure differential available across the valve to total head loss along the process line at various operating conditions.
- e. Operational data, such as:
 - maximum differential pressure with closed valve;
 - stroking time;
 - plug position in case of supply failure;
 - maximum allowable leakage of valve in closed position;
 - fire resistance;
 - maximum outwards leakage;
 - noise limitations.
- f. Interface information, such as:
 - sizing of downstream safety valves;
 - accessibility of the valve;
 - materials and type of piping connections;
 - overall dimensions, including the necessary space for disassembling and maintenance,
 - design pressure and temperature;
 - available supplies and their characteristics.

2. VALVE SPECIFICATION

On the basis of the above data it is possible to finalise the detailed specification of the valve (data sheet), i.e. to select:

- valve rating;
- body and valve type;
- body size, after having calculated the maximum flow coefficient C_v with the appropriate sizing equations;
- type of trim;
- materials trim of different trim parts;
- leakage class;
- inherent flow characteristic;
- packing type;
- type and size of actuator;
- accessories.

3. FLOW COEFFICIENT

The flow coefficient is the coefficient used to calculate the flow rate of a control valve under given conditions.

3.1 Flow coefficient K_v (metric units)

The flow coefficient K_v is the standard flow rate which flows through a valve at a given opening, referred to the following conditions:

- static pressure drop ($\Delta p_{(K_v)}$) across the valve of 1 bar (10^5 Pa);
- flowing fluid is water at a temperature from 5 to 40° C;
- the volumetric flow rate q_v is expressed in m^3/h .

The value of K_v can be determined from tests according to par. 3.3 using the following formula, valid at standard conditions only (refer to par. 3.3):

$$K_v = q_v \cdot \sqrt{\frac{\Delta p_{(K_v)}}{\Delta p} \cdot \frac{\rho_1}{\rho_0}}$$

where:

- $\Delta p_{(K_v)}$ is the static pressure drop of 10^5 Pa [Pa];
- Δp is the static pressure drop from upstream to downstream [Pa];
- ρ_1 is the specific mass of flowing fluid [kg/m^3];
- ρ_0 is the specific mass of water [kg/m^3].

Note: Simple conversion operations among the different units give the following relationship: $C_v \cong 1.16 K_v$.

Note: Although the flow coefficients were defined as liquid (water) flow rates, nevertheless they are used for control valve sizing both for incompressible and compressible fluids. Refer to par. 5.6 and 5.9 for more information.

3.2 Flow coefficient C_v (imperial units)

The flow coefficient C_v is the standard flow rate which flows through a valve at a given opening, referred to the following conditions:

- static pressure drop ($\Delta p_{(C_v)}$) across the valve of 1 psi (6 895 Pa);
- flowing fluid is water at a temperature from 40 to 100 F (5 to 40° C);
- the volumetric flow rate q_v is expressed in gpm.

The value of C_v can be determined from tests using the following formula, valid at standard conditions only (refer to par. 3.3):

$$C_v = q_v \cdot \sqrt{\frac{\Delta p_{(C_v)}}{\Delta p} \cdot \frac{\rho_1}{\rho_0}}$$

where:

- $\Delta p_{(C_v)}$ is the static pressure drop of 1 psi [psi];
- Δp is the static pressure drop from upstream to downstream [psi];
- ρ_1 is the specific mass of the flowing fluid [lb/ft^3];
- ρ_0 is the specific mass of the water [lb/ft^3].

3.3 Standard test conditions

The standard conditions referred to in definitions of flow coefficients (K_v , C_v) are the following:

- flow in turbulent condition;
- no cavitation and vaporisation phenomena;
- valve diameter equal to pipe diameter;
- static pressure drop measured between upstream and downstream pressure taps located as in Figure 1;
- straight pipe lengths upstream and downstream the valve as per Figure 1;
- Newtonian fluid.

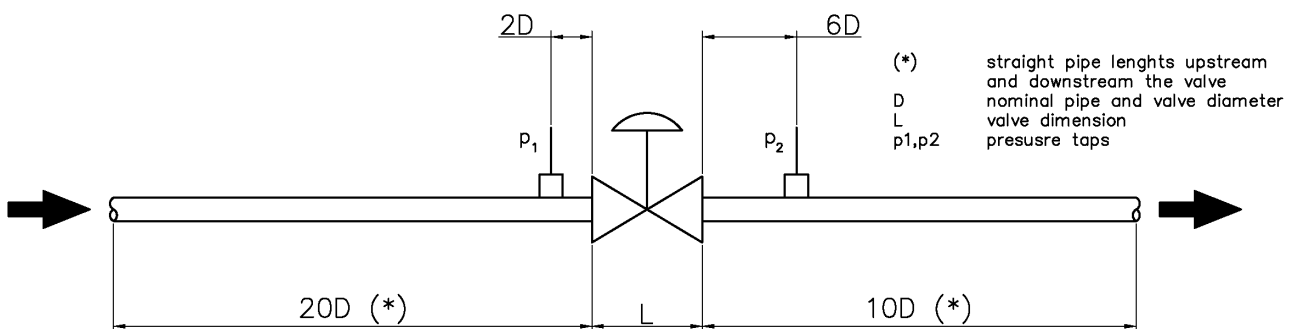

Figure 1 – Standard test set up.

4. SIZING EQUATIONS

Sizing equations allow to calculate a value of the flow coefficient starting from different operating conditions (type of fluid, pressure drop, flow rate, type of flow and installation) and making them mutually comparable as well as with the standard one.

The equations outlined in this chapter are in accordance with the standards IEC 60534-2-1 and IEC 60534-2-3.

4.1 Sizing equations for incompressible fluids (turbulent flow)

In general actual flow rate q_m of a incompressible fluid through a valve is plotted in Figure 2 versus the square root of the pressure differential $\sqrt{\Delta p}$ under constant upstream conditions.

The curve can be split into three regions:

- a first normal flow region (not critical), where the flow rate is exactly proportional to $\sqrt{\Delta p}$. This not critical flow condition takes place until $p_{vc} > p_v$.
- a second semi-critical flow region, where the flow rate still rises when the pressure drop is increased, but less than proportionally to $\sqrt{\Delta p}$. In this region the capability of the valve to convert the pressure drop increase into flow rate is reduced, due to the fluid vaporisation and the subsequent cavitation.
- In the third limit flow or saturation region the flow rate remains constant, in spite of further increments of $\sqrt{\Delta p}$.

This means that the flow conditions in vena contracta have reached the maximum evaporation rate (which depends on the upstream flow conditions) and the mean velocity is close to the sound velocity, as in a compressible fluid.

The standard sizing equations ignore the hatched area of the diagram shown in Figure 2, thus neglecting the semi-critical flow region. This approximation is justified by simplicity purposes and by the fact that it is not practically important to predict the exact flow rate in the hatched area; on the other hand such an area should be avoided, when possible, as it always involves vibrations and noise problems as well as mechanical problems due to cavitation.

Refer to Figure 4 for sizing equations in normal and limit flow.

4.2 Sizing equations for compressible fluids (turbulent flow)

The Figure 3 shows the flow rate diagram of a compressible fluid flowing through a valve when changing the downstream pressure under constant upstream conditions.

The flow rate is no longer proportional to the square root of the pressure differential $\sqrt{\Delta p}$ as in the case of incompressible fluids.

This deviation from linearity is due to the variation of fluid density (expansion) from the valve inlet up to the vena contracta.

Due to this density reduction the gas is accelerated up to a higher velocity than the one reached by an equivalent liquid mass flow. Under the same Δp the mass flow rate of a compressible fluid must therefore be lower than the one of an incompressible fluid.

Such an effect is taken into account by means of the expansion coefficient Y (refer to par. 5.6), whose value can change between 1 and 0.667.

Refer to Figure 4 for sizing equations in normal and limit flow.

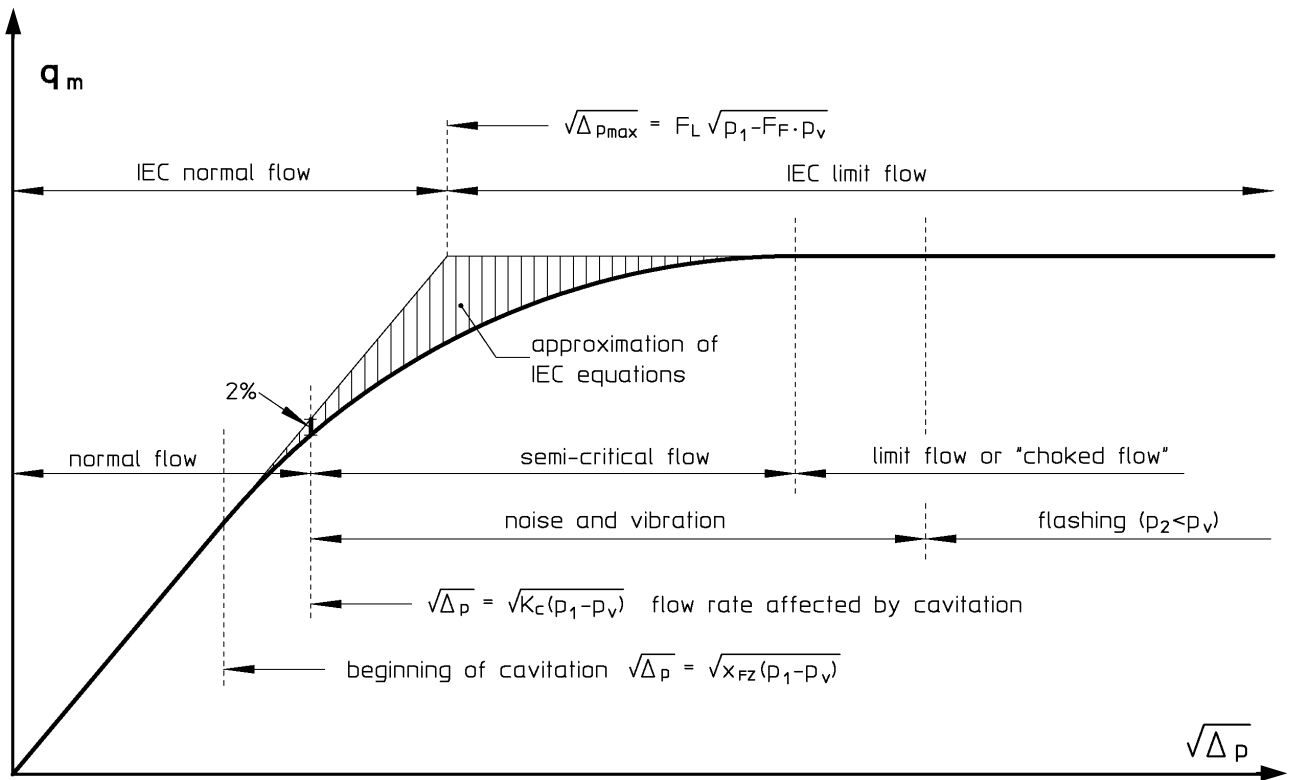

Figure 2 – Flow rate diagram of an **incompressible fluid** flowing through a valve plotted versus downstream pressure under constant upstream conditions.

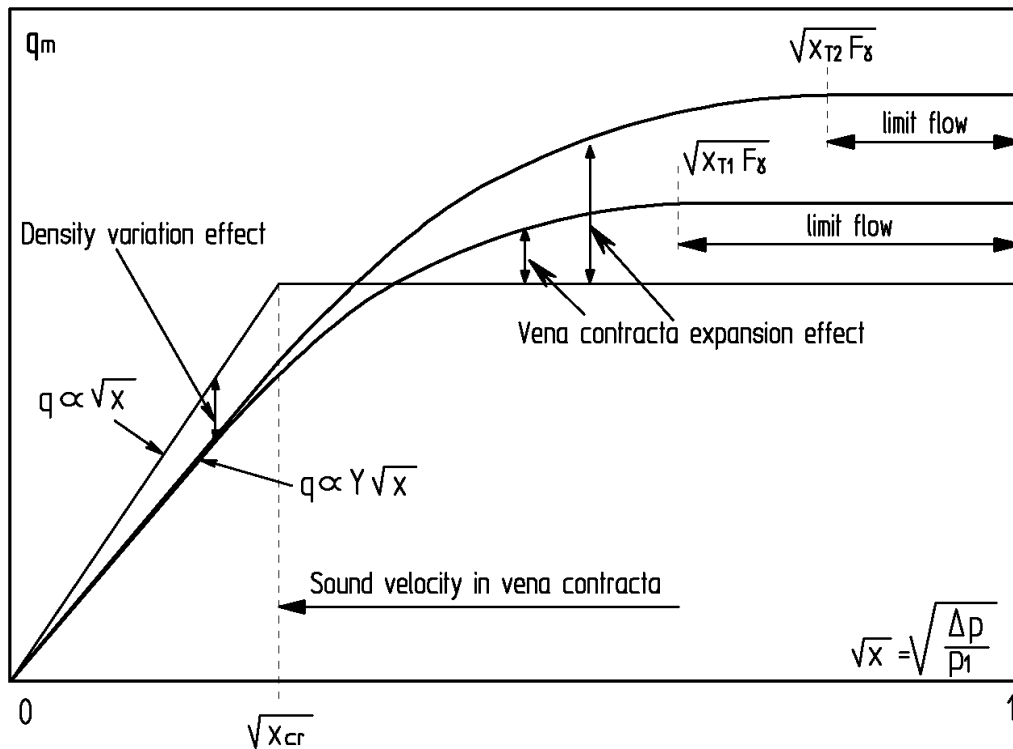

Figure 3 – Flow rate diagram of a **compressible fluid** flowing through a valve plotted versus differential pressure under constant upstream conditions.

Basic equations (valid for standard test conditions only, par. 3.3)																																	
$K_v = q_v \cdot \sqrt{\frac{\rho_1 / \rho_0^{water}}{\Delta p}} = \frac{q_v}{\sqrt{\Delta p}}$ $C_v = \frac{q_v}{0.865} \cdot \sqrt{\frac{\rho_1 / \rho_0^{water}}{\Delta p}} = \frac{q_v}{0.865 \cdot \sqrt{\Delta p}}$																																	
Sizing equations for incompressible fluids ⁽¹⁾	Sizing equations for compressible fluids ^{(2) (3)}																																
<p><i>Critical conditions</i></p> $\Delta p = p_1 - p_2 \geq \Delta p_{max} = \left(\frac{F_{LP}}{F_p} \right)^2 \cdot (p_1 - F_F \cdot p_v)$	<p><i>Critical conditions</i></p> $x = \frac{p_1 - p_2}{p_1} \geq F_\gamma \cdot x_T \text{ and/or } Y = 2/3 = 0.667$																																
<p>Normal flow (not critical) $\Delta p < \Delta p_{max}$</p> $C_v = \frac{q_m}{865 \cdot F_p \cdot \sqrt{\Delta p \cdot \rho_r}}$ $C_v = \frac{1.16 \cdot q_v}{F_p} \cdot \sqrt{\frac{\rho_r}{\Delta p}}$	<p>Normal flow (not critical) $x < F_\gamma \cdot x_T$ or $2/3 < Y \leq 1$</p> $C_v = \frac{q_m}{27.3 \cdot F_p \cdot Y \cdot \sqrt{x \cdot \rho_1 \cdot \rho_1}}$ $C_v = \frac{q_v}{2120 \cdot F_p \cdot \rho_1 \cdot Y} \cdot \sqrt{\frac{M \cdot T_1 \cdot Z}{x}}$																																
<p>Limit flow (critical or choked flow) $\Delta p \geq \Delta p_{max}$</p> $C_v = \frac{q_{m(max)}}{865 \cdot F_{LP} \cdot \sqrt{(p_1 - F_F \cdot p_v) \cdot \rho_r}}$ $C_v = \frac{1.16 \cdot q_{v(max)}}{F_{LP}} \cdot \sqrt{\frac{\rho_r}{p_1 - F_F \cdot p_v}}$	<p>Limit flow (critical or choked flow) $x \geq F_\gamma \cdot x_T$ and/or $Y = 2/3 = 0.667$</p> $C_v = \frac{q_{m(max)}}{18.2 \cdot F_p \cdot \sqrt{F_\gamma \cdot x_{TP} \cdot \rho_1 \cdot \rho_1}}$ $C_v = \frac{q_{v(max)}}{1414 \cdot F_p \cdot \rho_1} \cdot \sqrt{\frac{M \cdot T_1 \cdot Z}{F_\gamma \cdot x_{TP}}}$																																
Units	<table border="0"> <tr> <td>K_v</td> <td>[m³/h]</td> <td>p_1</td> <td>[bar a]</td> </tr> <tr> <td>C_v</td> <td>[gpm]</td> <td>p_2</td> <td>[bar a]</td> </tr> <tr> <td>$q_m, q_{m(max)}$</td> <td>[kg/h]</td> <td>p_c</td> <td>[bar a]</td> </tr> <tr> <td>$q_v, q_{v(max)}$</td> <td>[m³/h] for incompressible fluids [Nm³/h] for compressible fluids</td> <td>p_v</td> <td>[bar a]</td> </tr> <tr> <td>T</td> <td>[K]</td> <td>ρ_0</td> <td>[kg/m³] refer to Nomenclature</td> </tr> <tr> <td>M</td> <td>[kg/kmol]</td> <td>ρ_1</td> <td>[kg/m³]</td> </tr> <tr> <td>Δp</td> <td>[bar]</td> <td>ρ_r</td> <td>[-]</td> </tr> <tr> <td></td> <td></td> <td>Y</td> <td>[-] refer to par. 5.6</td> </tr> </table>	K_v	[m ³ /h]	p_1	[bar a]	C_v	[gpm]	p_2	[bar a]	$q_m, q_{m(max)}$	[kg/h]	p_c	[bar a]	$q_v, q_{v(max)}$	[m ³ /h] for incompressible fluids [Nm ³ /h] for compressible fluids	p_v	[bar a]	T	[K]	ρ_0	[kg/m ³] refer to Nomenclature	M	[kg/kmol]	ρ_1	[kg/m ³]	Δp	[bar]	ρ_r	[-]			Y	[-] refer to par. 5.6
K_v	[m ³ /h]	p_1	[bar a]																														
C_v	[gpm]	p_2	[bar a]																														
$q_m, q_{m(max)}$	[kg/h]	p_c	[bar a]																														
$q_v, q_{v(max)}$	[m ³ /h] for incompressible fluids [Nm ³ /h] for compressible fluids	p_v	[bar a]																														
T	[K]	ρ_0	[kg/m ³] refer to Nomenclature																														
M	[kg/kmol]	ρ_1	[kg/m ³]																														
Δp	[bar]	ρ_r	[-]																														
		Y	[-] refer to par. 5.6																														
Notes	<p>1) For valve without reducers: $F_p = 1$ and $F_{LP} = F_L$</p> <p>2) For valve without reducers: $F_p = 1$ and $x_{TP} = x_T$</p> <p>3) Formula with volumetric flow rate q_v [Nm³/h] refers to normal conditions (1 013.25 mbar absolute and 273 K). For use with volumetric flow rate q_v [Sm³/h] in standard conditions (1 013.25 mbar absolute and 288.6 K), replace constants 2120 and 1414 with 2250 and 1501 respectively.</p>																																

Figure 4 – Basic and sizing equations both for incompressible and for compressible fluids for turbulent flow regime (source: IEC 60534-2-1 and IEC 60534-2-3).

4.3 Sizing equations for two-phase flows

No standard formulas presently exist for the calculation of two-phase flow rates through orifices or control valves.

The following methods are based on THINKTANK experience

and on the available literature; conservatively, THINKTANK

suggest to size the valve using both methods and to assume the higher flow coefficient resulting from calculations.

4.3.1 Liquid/gas mixtures at valve inlet

In case of valve sizing with liquid/gas mixtures without mass and energy transfer between the phases, two physical models can be applied.

The first model is applicable for low volume fractions of the gas phase in vena contracta, typically lower than 50% (for the evaluation of the volume fractions in vena contracta refer to paragraph 4.3.3).

The method consists in the independent calculation of flow coefficients for the gaseous phase and for the liquid phase. Required flow coefficient is assumed as the sum:

$$C_v = C_{v.g} + C_{v.liq}$$

This model roughly considers separately the flows of the two phases through the valve orifice without mutual energy exchange, assuming that the mean velocities of the two phases in the vena contracta are considerably different.

The second model overcomes the above limitation assuming that the two phases cross the vena contracta at the same velocity. It is usually applicable for high volume fractions of the gas phase in vena contracta.

According to formulas in Figure 4, the mass flow rate of a gas is proportional to the term:

$$q_m \div Y \cdot \sqrt{x \cdot \rho_1}$$

Defining the actual specific volume of the gas v_{eg} as:

$$v_{eg} = \frac{v_{g1}}{Y^2}$$

the above relation can be rewritten as:

$$q_m \div Y \cdot \sqrt{\frac{x}{v_{g1}}} = \sqrt{\frac{x}{v_{eg}}}$$

In other terms, this means to assume that the mass flow of a gas with specific volume v_{g1} is equivalent to the mass flow of a liquid with specific volume v_{eg} under the same operating conditions.

Assuming:

$$v_e = f_g \cdot \frac{v_{g1}}{Y^2} + f_{liq} \cdot v_{liq1}$$

where f_g and f_{liq} are respectively the gaseous and the liquid mass fraction of the mixture, and keeping in mind that when Y reaches the value of 0.667 the flow is limit

(refer to par. 5.6), the sizing equations are:

normal flow

$$C_v = \frac{q_m}{27.3 \cdot F_p \cdot \sqrt{\frac{x \cdot \rho_1}{v_e}}} = \frac{q_m}{27.3 \cdot F_p} \cdot \sqrt{\frac{v_e}{\Delta p}}$$

limit flow

$$C_v = \frac{q_m}{27.3 \cdot F_p} \cdot \sqrt{\frac{v_e}{F_\gamma \cdot x_{TP} \cdot \rho_1}}$$

4.3.2 Liquid/vapour mixtures at valve inlet

The calculation of the flow rate of a liquid mixed with its own vapour through a valve is very complex because of the mass and energy transfer between the two phases.

No formulas are presently available to calculate with sufficient accuracy the flow capacity of a valve in these conditions.

On the basis of the above considerations, it is common practice that:

- for low vapour quality at valve inlet, the most suitable equation is the one obtained from the sum of the flow capacities of the two phases (at different flow velocities):

$$C_v = C_{v.liq} + C_{v.vap}$$

- for high vapour quality at valve inlet, the most suitable equation is the one obtained from the hypothesis of equal velocities of the two phases, i.e. of the equivalent specific volume v_e , as shown in par. 4.3.1.

4.3.3 Evaluation of volume fractions in vena contracta

The selection of proper sizing method between those listed in par. 4.3.1 depends by the ratio between the volume fractions in vena contracta of gas and liquid, respectively q_{vol_gas} and q_{vol_liq} .

The volume fractions are evaluated as follows:

$$q_{vol_gas} = q_m \cdot f_g \cdot v_{liq1} \cdot \frac{\rho_1}{\rho_{vc}}$$

$$q_{vol_liq} = q_m \cdot f_{liq} \cdot v_{liq1}$$

The pressure in vena contracta p_{vc} , can be estimated from the definition of the liquid pressure recovery factor F_L (refer to par. 5.1).

4.4 Sizing equations for non-turbulent flow

Sizing equations of par. 4.1 and 4.2 are applicable in turbulent flow conditions, i.e. when the Reynolds number calculated inside the valve is higher than about 10 000 (refer to par. 5.9).

The well-known Reynolds number:

$$Re = \frac{\rho \cdot u \cdot d}{\mu}$$

is the dimensionless ratio between mass forces and viscous forces. When the first prevails the flow is turbulent; otherwise it is laminar.

Should the fluid be very viscous or the flow rate very low, or the valve very small, or a combination of the above conditions, a laminar type flow (or transitional flow) takes place in the valve and the C_v coefficient calculated in turbulent flow condition must be corrected by F_R coefficient.

Due to that above, factor F_R becomes a fundamental parameter to properly size the *low flow control valves* i.e. the valves having flow coefficients C_v from approximately 1.0 gpm down to the micro-flows range.

In such valves non-turbulent flow conditions do commonly exist with conventional fluids too (air, water, steam etc.) and standard sizing equations become unsuitable if proper coefficients are not used.

The equations for non-turbulent flow are derived from those outlined in Figure 4 for non limit flow conditions and modified with the correction factors F_R and Y_R , respectively the Reynolds number factor and the expansion factor in non-turbulent conditions.

The sizing equations for non-turbulent flow are listed in Figure 5.

The choked flow condition was ignored not being consistent with laminar flow.

Note the absence of piping factor F_p defined for turbulent flow. This because the effect of fittings attached to the valve is probably negligible in laminar flow condition and it is actually unknown.

	Sizing equations for incompressible fluids	Sizing equations for compressible fluids ⁽¹⁾
Non-turbulent flow regime (laminar and transitional flow)	$C_v = \frac{q_m}{865 \cdot F_R \cdot \sqrt{\Delta p \cdot \rho_f}}$ $C_v = \frac{1.16 \cdot q_v}{F_R} \cdot \sqrt{\frac{\rho_f}{\Delta p}}$	$C_v = \frac{q_m}{67 \cdot F_R \cdot Y_R} \cdot \sqrt{\frac{T_1}{\Delta p \cdot \left(\rho_1 + p_2 \right) M}}$ $C_v = \frac{q_v}{1500 \cdot F_R \cdot Y_R} \cdot \sqrt{\frac{M \cdot T_1}{\Delta p \cdot \left(\rho_1 + p_2 \right)}}$
	Expansion factor Y_R	
	$Re_v < 1000$ $Y_R = \sqrt{1 - \frac{x}{2}}$	$1000 \leq Re_v < 10000$ $Y_R = \frac{Re_v - 1000}{9000} \cdot \left(1 - \frac{x}{3 \cdot F_y \cdot x_T} - \sqrt{1 - \frac{x}{2}} \right) + \sqrt{1 - \frac{x}{2}}$
	Reynolds number factor F_R	
	<p style="text-align: center;">laminar flow $Re_v < 10$</p> $F_R = \min \left[\frac{0.026}{F_L} \cdot \sqrt{n \cdot Re_v}, 1.00 \right]$	<p style="text-align: center;">transitional flow $10 \leq Re_v < 10000$</p> $F_R = \min \left[1 + \left(\frac{0.33 \cdot F_L^{1/2}}{n^{1/4}} \right) \cdot \log \left(\frac{Re_v}{10000} \right), \frac{0.026}{F_L} \cdot \sqrt{n \cdot Re_v}, 1.00 \right]$
	Trim style constant n	
	<p>full size trim $\left(C_v / d^2 \right) \geq 0.016$</p> <p>reduced trim $\left(C_v / d^2 \right) < 0.016$</p>	$n = \frac{467.3}{\left(C_v / d^2 \right)^2}$ $n = 1 + 127 \cdot \left(C_v / d^2 \right)^{2/3}$
Units	C_v [gpm] q_m [kg/h] q_v [m ³ /h] for incompressible fluids [Nm ³ /h] for compressible fluids T [K] M [kg/kmol] Δp [bar]	p_1 [bar a] p_2 [bar a] ρ_f [-] F_R [-] refer to par. 5.9 Y_R [-] refer to par. 5.9 Re_v [-] refer to par. 5.9 d [mm]
Notes	<p>1) Formula with volumetric flow rate q_v [Nm³/h] refers to normal conditions (1 013.25 mbar absolute and 273 K). For use with volumetric flow rate q_v [Sm³/h] in standard conditions (1 013.25 mbar absolute and 288.6 K), replace constant 1500 with 1590.</p>	

Figure 5 – Sizing equations both for incompressible and for compressible fluids for non-turbulent flow regime (source: IEC 60534-2-1).

5. PARAMETERS OF SIZING EQUATIONS

In addition to the flow coefficient some other parameters occur in sizing equations with the purpose to identify the different flow types (normal, semi-critical, critical, limit); such parameters only depend on the flow pattern inside the valve body. In many cases such parameters are of primary importance for the selection of the right valve for a given service. It is therefore necessary to know the values of such parameters for the different valve types at full opening as well as at other stroke percentages.

Such parameters are:

- F_L liquid pressure recovery factor (for incompressible fluids);
- x_{FZ} coefficient of incipient cavitation;
- K_c coefficient of constant cavitation;
- F_P piping geometry factor;
- F_{LP} combined coefficient of F_L with F_P ;
- F_F liquid critical pressure ratio factor;
- Y expansion factor (for compressible fluids);
- x_T pressure differential ratio factor in choked condition;
- x_{TP} combined coefficient of F_P with x_T ;
- F_R Reynolds number factor;
- F_d valve style modifier.

5.1 Liquid pressure recovery factor F_L

The recovery factor of a valve only depends on the shape of the body and the trim. It shows the valve capability to transform the kinetic energy of the fluid in the vena contracta into pressure energy. It is defined as follows:

$$F_L = \sqrt{\frac{p_1 - p_2}{p_1 - p_{vc}}}$$

Since the pressure in vena contracta p_{vc} is always lower than p_2 , it is always $F_L \leq 1$. Moreover it is important to remark that the lower is this coefficient the higher is the valve capability to transform the kinetic energy into pressure energy (high recovery valve).

The higher this coefficient is (close to 1) the higher is the valve attitude to dissipate energy by friction rather than in vortices, with consequently lower reconversion of kinetic energy into pressure energy (low recovery valve). In practice, the sizing equations simply refer to the pressure drop ($p_1 - p_2$) between valve inlet and outlet and until the pressure p_{vc} in vena contracta is higher than the saturation pressure p_v of the fluid at valve inlet, then the influence of the recovery factor is practically negligible and it does not matter whether the valve dissipates pressures energy by friction rather than in whirlpools.

The F_L coefficient is crucial when approaching to cavitation, which can be avoided selecting a lower recovery valve.

a. Determination of F_L

Since it is not easy to measure the pressure in the vena contracta with the necessary accuracy, the recovery factor is determined in critical conditions:

$$F_L = \frac{1.16 \cdot q_{v(max)}}{C_v \cdot \sqrt{p_1 - 0.96 \cdot p_v}}$$

The above formula is valid using water as test fluid.

Critical conditions are reached with a relatively high inlet pressure and reducing the outlet pressure p_2 until the flow rate does not increase any longer and this flow rate is assumed as $q_{v(max)}$. F_L can be determined measuring only the pressure p_1 and $q_{v(max)}$.

b. Accuracy in determination of F_L

It is relatively easier determining the critical flow rate $q_{v(max)}$ for high recovery valves (low F_L) than for low recovery valves (high F_L). The accuracy in the determination of F_L for values higher than 0.9 is not so important for the calculation of the flow capacity as to enable to correctly predict the cavitation phenomenon for services with high differential pressure.

c. Variation of F_L versus valve opening and flow direction

The recovery factor depends on the profile of velocities which takes place inside the valve body. Since this last changes with the valve opening, the F_L coefficient considerably varies along the stroke and, for the same reason, is often strongly affected by the flow direction. The Figure 6 shows the values of the recovery factor versus the plug stroke for different valve types and the two flow directions.

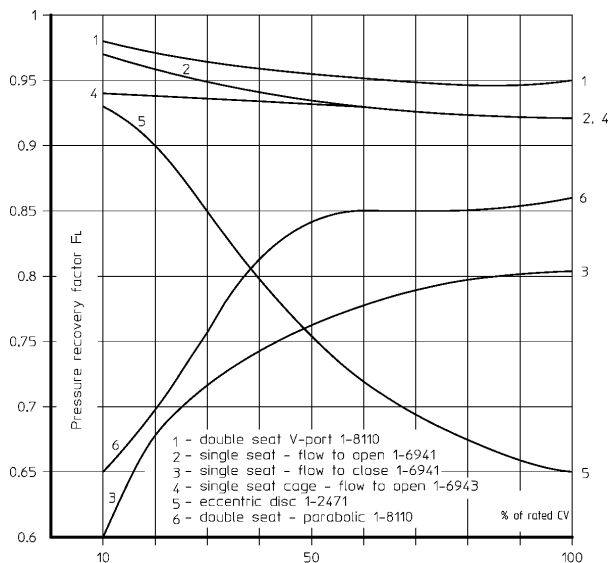

Figure 6 – Typical F_L values versus C_v % and flow direction for different THINKTANK valve types.

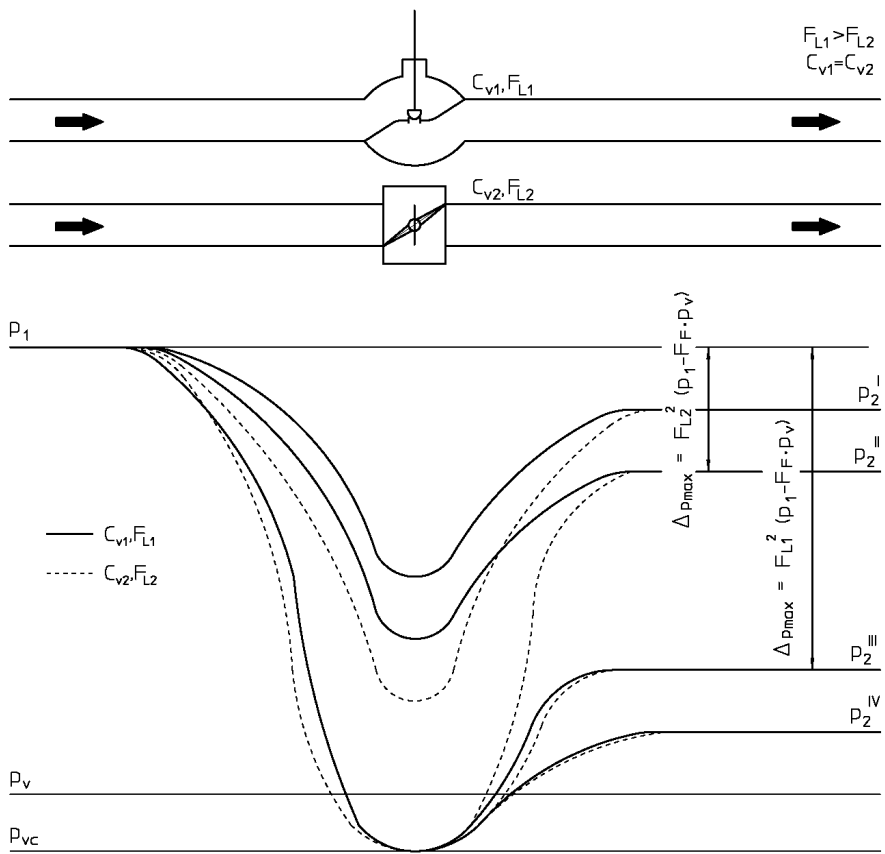

Figure 7 – Comparison between two valves with equal flow coefficient but with different recovery factor, under the same inlet fluid condition. When varying the downstream pressure, at the same values of C_v , p_1 and p_2 , valves with higher F_L can accept higher flow rates of fluid.

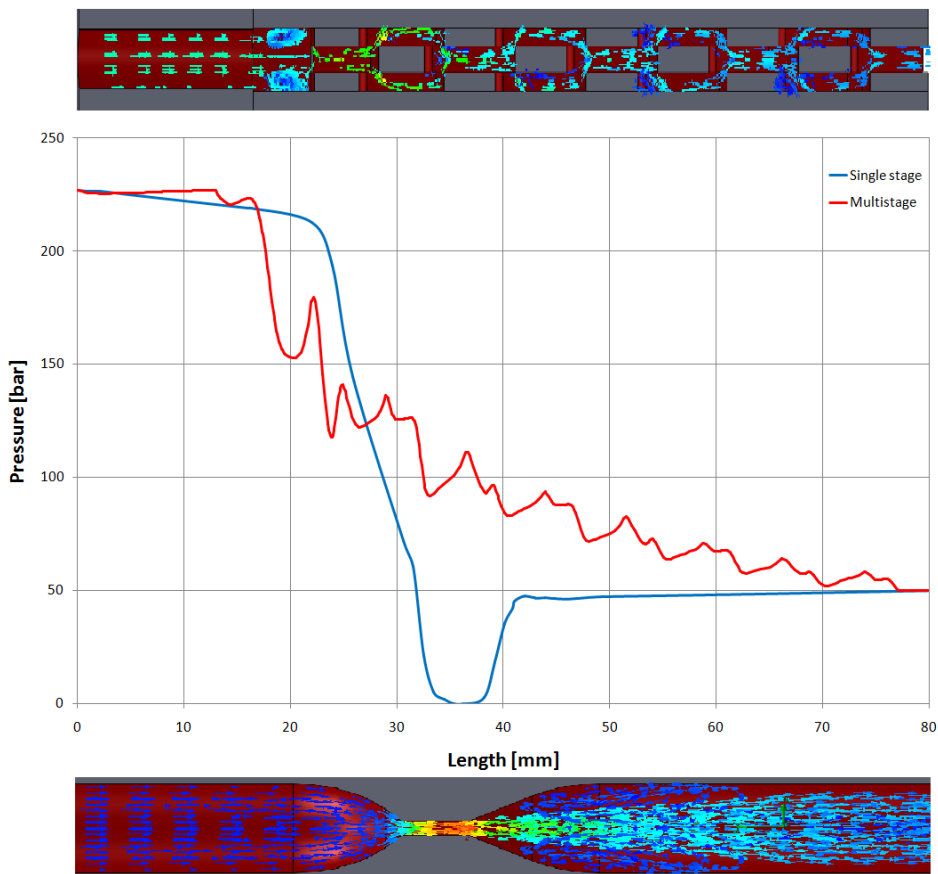

Figure 8 – Pressure drop comparison between single stage (venturi nozzle) and multistage multipath (*Limiphon™* trim) on liquid service using CFD analysis.

5.2 Coefficient of incipient cavitation x_{FZ} and coefficient of constant cavitation K_C

When in the vena contracta a pressure lower than the saturation pressure is reached then the liquid evaporates, forming vapour bubbles.

If, due to pressure recovery, the downstream pressure (which only depends on the downstream piping layout) is higher than the critical pressure in the vena contracta, then vapour bubbles totally or partially implode, instantly collapsing.

This phenomenon is called cavitation and causes well known damages due to high local pressures generated by the vapour bubbly implosion. Metal surface damaged by the cavitation show a typical pitted look with many micro and macro pits. The higher is the number of imploding bubbles the higher are damaging speed and magnitude; these depend on the elasticity of the media where the implosion takes place (i.e. on the fluid temperature) as well as on the hardness of the metal surface (see table in Figure 9).

Critical conditions are obviously reached gradually. Moreover the velocity profile in the vena contracta is not completely uniform, hence may be that a part only of the flow reaches the vaporization pressure. The F_L recovery factor is determined in proximity of fully critical conditions, so it is not suitable to predict an absolute absence of vaporization.

Usually the beginning of cavitation is identified by the coefficient of incipient cavitation x_{FZ} :

$$x_{FZ} = \frac{\Delta p_{tr}}{p_1 - p_v}$$

where Δp_{tr} is the value of differential pressure where transition takes place from non cavitating to cavitating flow.

The x_{FZ} coefficient can be determined by test using sound level meters or accelerometers connected to the pipe and relating noise and vibration increase with the beginning of bubble formation.

Some information on this regard are given by standard IEC 60534-8-2 "Laboratory measurement of the noise generated by a liquid flow through a control valve", which the Figure 10 was drawn from.

Index of resistance to cavitation	
stellite gr.6	20
chrome plating	(5)
17-4 PH H900	2
AISI 316/304	1
monel 400	(0.8)
gray cast iron	0.75
chrome-molybdenum alloyed steels (5% chrome)	0.67
carbon steels (WCB)	0.38
bronze (B16)	0.08
nickel plating	(0.07)
pure aluminium	0.006

Figure 9 – Cavitation resistance of some metallic materials referred to stainless steels AISI 304/316. Values between brackets are listed for qualitative comparison only.

In order to detect the beginning of the constant bubble formation, i.e. the constant cavitation, the coefficient K_C is defined as:

$$K_C = \frac{\Delta p}{p_1 - p_v}$$

It identifies where the cavitation begins to appear in a water flow through the valve with such an intensity that, under constant upstream conditions, the flow rate deviation from the linearity versus $\sqrt{\Delta p}$ **exceeds 2%**.

A simple calculation rule uses the formula:

$$K_C = 0.80 \cdot F_L^2$$

Such a simplification is however only acceptable when the diagram of the actual flow rate versus $\sqrt{\Delta p}$, under constant upstream conditions, shows a sharp break point between the linear/proportional zone and the horizontal one.

If, on the contrary, the break point radius is larger (i.e. if the Δp at which the deviation from the linearity takes place is different from the Δp at which the limit flow rate is reached), then the coefficient of proportionality between K_C and F_L^2 can come down to 0.65.

Since the coefficient of constant cavitation changes with the valve opening, it is usually referred to a 75% opening.

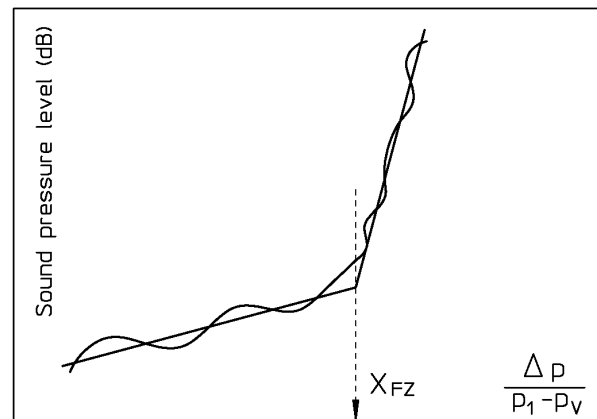

Figure 10 – Determination of the coefficient of incipient cavitation by means of phonometric analysis (source: IEC 60534-8-2).

5.3 Piping geometry factor F_p

According to par. 3.3, the flow coefficients of a given valve type are determined under standard conditions of installation.

The actual piping geometry will obviously differ from the standard one.

The coefficient F_p takes into account the way that a reducer, an expander, a Y or T branch, a bend or a shut-off valve affect the value of C_v of a control valve.

A calculation can only be carried out for pressure and velocity changes caused by reducers and expanders directly connected to the valve. Other effects, such as the ones caused by a change in velocity profile at valve inlet due to reducers or other fittings like a short radius bend close to the valve, can only be evaluated by specific tests. Moreover such perturbations could involve undesired effects, such as plug instability due to asymmetrical and unbalancing fluid dynamic forces.

When the flow coefficient must be determined within $\pm 5\%$ tolerance the F_p coefficient must be determined by test.

When estimated values are permissible the following equation may be used:

$$F_p = \frac{1}{\sqrt{1 + \frac{\Sigma K}{0.00214} \cdot \left(\frac{C_v}{d^2}\right)^2}}$$

where:

- C_v is the selected flow coefficient [gpm];
- d is the nominal valve size [mm];
- ΣK is defined as $\Sigma K = K_1 + K_2 + K_{B1} - K_{B2}$, with:
 - K_1 and K_2 are resistance coefficient which take into account head losses due to turbulences and frictions respectively at valve inlet and outlet (see Figure 11);
 - K_{B1} and K_{B2} are the so called Bernoulli coefficients, which account for the pressure changes due to velocity changes due to reducers or expanders, respectively at valve inlet and outlet (see Figure 11); in case of the same ratio d/D for reducer and expander, their sum is null;
- D is the internal diameter of the piping [mm].

Inlet reducer:	$K_1 = 0.5 \cdot \left[1 - \left(\frac{d}{D_1}\right)^2\right]^2$
Outlet expander:	$K_2 = 1.0 \cdot \left[1 - \left(\frac{d}{D_2}\right)^2\right]^2$
In case of the same ratio d/D for reducer and expander:	$K_1 + K_2 = 1.5 \cdot \left[1 - \left(\frac{d}{D}\right)^2\right]^2$
In case of different ratio d/D for reducer and expander:	$K_{B1} = 1 - \left(\frac{d}{D_1}\right)^4$ $K_{B2} = 1 - \left(\frac{d}{D_2}\right)^4$

Figure 11 – Resistance and Bernoulli coefficients.

5.4 Combined liquid pressure recovery factor and piping geometry factor of a control valve with attached fittings F_{LP}

Reducers, expanders, fittings and, generally speaking, any installation not according to the standard test manifold not only affect the standard coefficient (changing the actual inlet and outlet pressures), but also modify the transition point between normal and choked flow, so that Δp_{max} is no longer equal to $F_L^2 \cdot (p_1 - F_F \cdot p_v)$, but it becomes:

$$\Delta p_{max} = \left(\frac{F_{LP}}{F_p}\right)^2 \cdot (p_1 - F_F \cdot p_v)$$

As for the recovery factor F_L , the coefficient F_{LP} is determined by test (refer to par. 5.1.a):

$$F_{LP} = \frac{1.16 \cdot q_{v(max)LP}}{C_v \cdot \sqrt{p_1 - 0.96 \cdot p_v}}$$

The above formula is valid using water as test fluid.

When F_L is known, it can also be determined by the following relationship:

$$F_{LP} = \frac{F_L}{\sqrt{1 + \frac{F_L^2}{0.00214} \cdot \left(\frac{C_v}{d^2}\right)^2}}$$

where $\left(\frac{C_v}{d^2}\right)^2 = K_1 + K_{B1}$ is the velocity head loss coefficient of the fitting upstream the valve, as measured between the upstream pressure tap and the control valve body inlet. For detail of terms refer to par. 5.3 and Figure 11.

5.5 Liquid critical pressure ratio factor F_F

The coefficient F_F is the ratio between the apparent pressure in vena contracta in choked condition and the vapour pressure of the liquid at inlet temperature:

$$F_F = \frac{p_{vc}}{p_v}$$

When the flow is at limit conditions (saturation) the flow rate equation must no longer be expressed as a function of the differential pressure across the valve ($\Delta p = p_1 - p_2$), but as function of the differential pressure in vena contracta ($\Delta p_{vc} = p_1 - p_{vc}$). Starting from the basic equation (refer to par. 4.1):

$$q_v = C_v \cdot \sqrt{\frac{p_1 - p_2}{\rho_r}}$$

And from:

$$F_L = \sqrt{\frac{p_1 - p_2}{p_1 - p_{vc}}}$$

The following equation is obtained:

$$q_v = F_L \cdot C_v \cdot \sqrt{\frac{p_1 - p_{vc}}{\rho_r}}$$

Expressing the differential pressure in vena contracta p_{vc} as function of the vapour pressure ($p_{vc} = F_F \cdot p_v$), the flow rate can be calculated as:

$$q_v = F_L \cdot C_v \cdot \sqrt{\frac{p_1 - F_F \cdot p_v}{\rho_c}}$$

Supposing that at saturation conditions the fluid is a homogeneous mixture of liquid and its vapour with the two phases at the same velocity and in thermodynamic equilibrium, the following equation may be used:

$$F_F = 0.96 - 0.28 \cdot \sqrt{\frac{p_v}{p_c}}$$

where p_c is the fluid critical thermodynamic pressure. Refer to Figure 13 for plotted curves of generic liquid and for water.

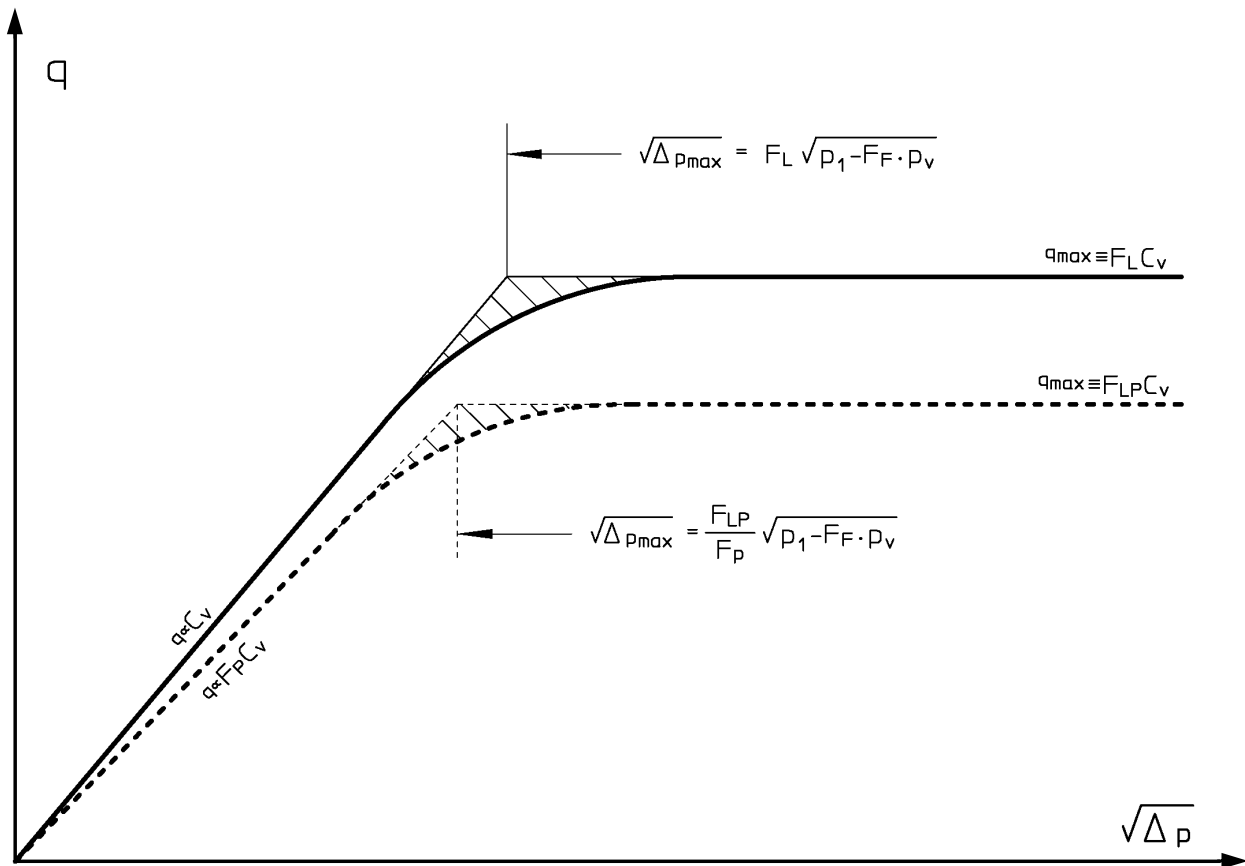

Figure 12 – Effect of reducers on the diagram of q versus $\sqrt{\Delta p}$ when varying the downstream pressure at constant upstream pressure.

5.6 Expansion factor Y and specific heat ratio factor F_γ

The expansion factor Y allows to use for compressible fluids the same equation structure valid for incompressible fluids.

It has the same nature of the expansion factor utilized in the equations of the throttling type devices (orifices, nozzles or Venturi) for the measure of the flow rate.

The Y's equation is obtained from the theory on the basis of the following hypothesis (experimentally confirmed):

1. Y is a linear function of $x = \Delta p/p_1$;
2. Y is function of the geometry (i.e. type) of the valve;
3. Y is a function of the fluid type, namely the exponent of the adiabatic transformation $\gamma = c_p/c_v$.

From the first hypothesis:

$$Y = 1 - a \cdot x$$

therefore:

$$q_m \div Y \cdot \sqrt{x}$$

A mathematic procedure allows to calculate the value of Y which makes maximum the above function (this means finding the point where the rate dq_m/dx becomes zero):

$$q_m \div (1 - a \cdot x) \cdot \sqrt{x} = \sqrt{x} - a \cdot \sqrt{x^3}$$

By setting:

$$\frac{dq_m}{dx} = \frac{1}{2 \cdot \sqrt{x}} - \frac{3 \cdot a \cdot \sqrt{x}}{2} = 0$$

$$\frac{1}{\sqrt{x}} = 3 \cdot a \cdot \sqrt{x} \text{ hence: } x = \frac{1}{3 \cdot a}$$

$$\text{i.e.: } Y = 1 - \frac{1}{3 \cdot a} \cdot a = \frac{2}{3}$$

As $Y = 1$ when $x = 0$ and $Y = 2/3 = 0.667$, when the flow rate is maximum (i.e. $x = x_T$) the equation of Y becomes the following:

$$Y = 1 - \frac{x}{3 \cdot x_T}$$

thus taking into account also the second hypothesis. In fact, x_T is an experimental value to be determined for each valve type.

Finally the third hypothesis will be taken into account with an appropriate correction factor, the specific heat ratio factor F_γ , which is the ratio between the exponent of the adiabatic transformation for the actual gas and the one for air:

$$F_\gamma = \frac{\gamma}{1.4}$$

The final equation becomes:

$$Y = 1 - \frac{x}{3 \cdot F_\gamma \cdot x_T}$$

Therefore the maximum flow rate is reached when:

$$x = F_\gamma \cdot x_T$$

(or $x = F_\gamma \cdot x_{TP}$ if the valve is supplied with reducers).

Correspondently the expansion factor reaches the minimum value of 0.667.

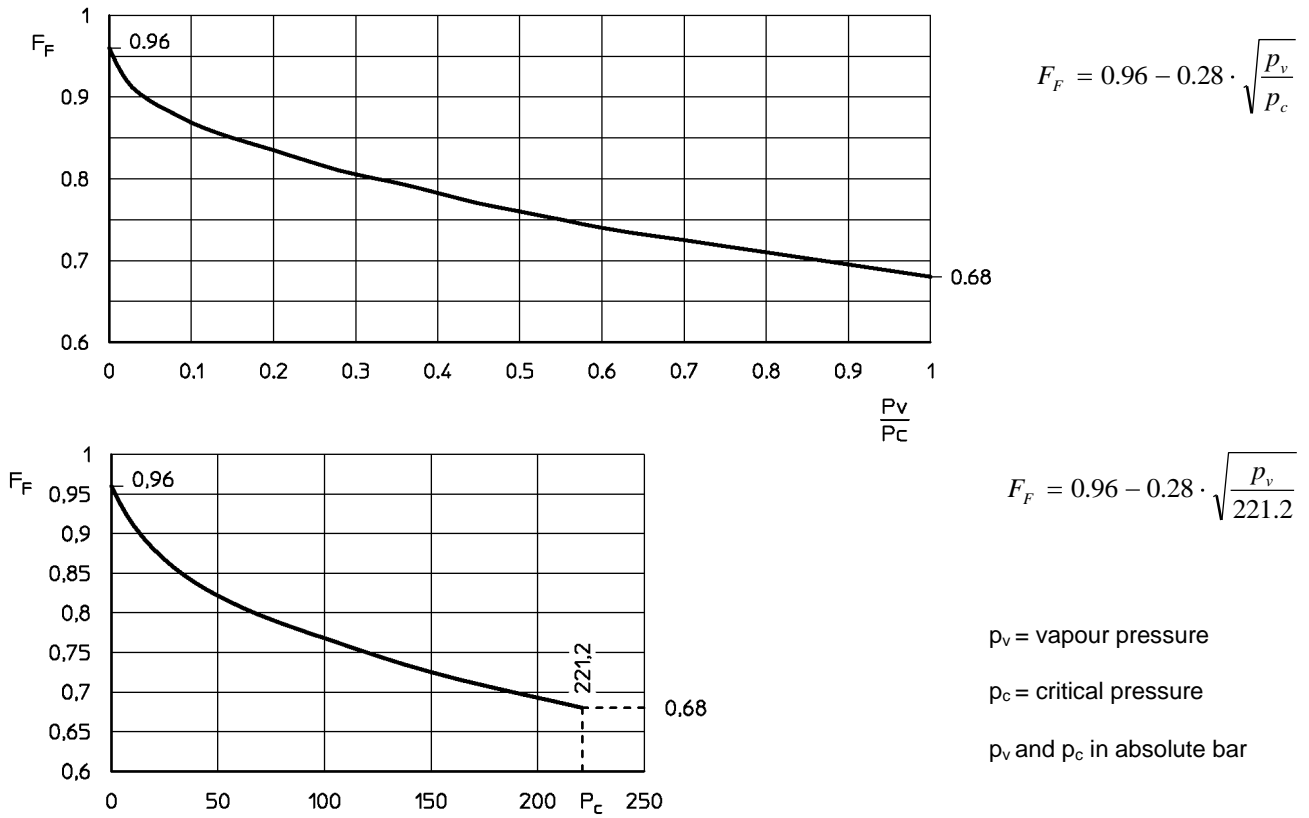

Figure 13 – Liquid critical pressure ratio factor F_F (for a generic liquid above, for water under).

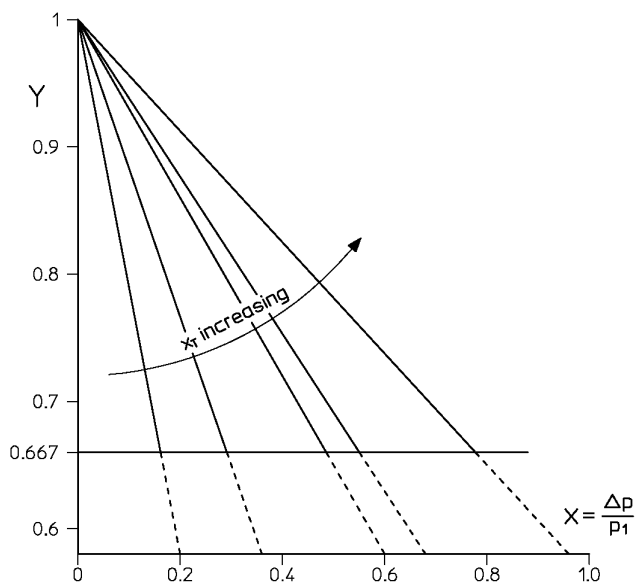

Figure 14 – Expansion factor Y . The diagram is valid for a given F_F value.

5.7 Pressure differential ratio factor in choked flow condition x_T

The recovery factor F_L does not occur in sizing equations for compressible fluids. Its use is unsuitable for gas and vapours because of the following physical phenomenon.

Assume that in a given section of the valve, under a given value of the downstream pressure p_2 , the sound velocity is reached. The critical differential ratio:

$$x_{cr} = \left(\frac{\Delta p}{p_1} \right)_{cr}$$

is reached as well, being:

$$x_{cr} = F_L^2 \cdot \left[1 - \left(\frac{2}{\gamma + 1} \right)^{\frac{\gamma}{\gamma - 1}} \right]$$

If the downstream pressure p_2 is further reduced, the flow rate still increases, as, due to the specific internal geometry of the valve, the section of the vena contracta widens transversally (it is not physically confined into solid walls).

A confined vena contracta can be got for instance in a Venturi meter to measure flow rate: for such a geometry, once the sound velocity is reached for a given value of p_2 , the relevant flow rate remains constant, even reducing further p_2 .

Nevertheless the flow rate does not unlimitedly increase, but only up to a given value of $\Delta p / p_1$ (to be determined by test), the so called pressure differential ratio factor in choked flow condition, x_T .

Although some relationships between x_T and F_L are available, reliable values of x_T must be obtained only by tests, as the internal geometry of body governs either the head losses inside the body and the expansion mode of vena contracta. If vena contracta is free to expand the relationship between x_T and F_L may be approximately the following:

$$x_T \cong 0.85 \cdot F_L^2$$

On the contrary, if vena contracta is fully confined by the inner body walls (Venturi shape) and the pressure losses inside the body are negligible, x_T tends to be coincident with x_{cr} .

5.8 Pressure differential ratio factor in choked flow condition for a valve with reducers x_{TP}

The factor x_{TP} is the same factor x_T but determined on valves supplied with reducers or installed differently from the standard set up as required in par. 3.3.

It is determined by tests using the following formula:

$$x_{TP} = \frac{x_T}{F_p^2} \cdot \frac{1}{1 + \frac{x_T \cdot (K_1 + K_{BT})}{0.00241} \left(\frac{C_v}{d^2} \right)^2}$$

Being the flow coefficient C_v in the above formula is the calculated one, an iterative calculation has to be used.

Valve type	Trim type	Flow direction	F_L	x_T	F_d	
Globe, single port	Contoured plug (linear and equal percentage)	Open	0.90	0.72	0.46	
		Close	0.80	0.55	1.00	
Globe, angle	Contoured plug (linear and equal percentage)	Open	0.90	0.72	0.46	
		Close	0.80	0.65	1.00	
Butterfly, eccentric shaft	Offset seat (70°)	Either	0.67	0.35	0.57	
Globe and angle	Multistage, multipath	Either	2	0.97	0.812	-
			3	0.99	0.888	-
			4	0.99	0.925	-
			5	0.99	0.950	-

Figure 15 – Typical values of liquid pressure recovery factor F_L , pressure differential ratio factor x_T and valve style modifier F_d at full rated stroke (source: IEC 60534-2-1).

5.9 Reynolds number factor F_R

The F_R factor is defined as the ratio between the flow coefficient C_V for not turbulent flow, and the corresponding coefficient calculated for turbulent flow under the same conditions of installation.

$$F_R = \frac{C_{V_non-turbulent}}{C_{V_turbulent}}$$

The F_R factor is determined by tests and can be calculated with the formulas listed in table of Figure 5. It is function of the valve Reynolds number Re_v which can be determined by the following relationship:

$$Re_v = \frac{0.076 \cdot F_D \cdot q_v}{v \cdot \sqrt{F_L \cdot C_V}} \cdot \sqrt[4]{\frac{F_L^2 \cdot C_V^2}{0.00214 \cdot D^4} + 1}$$

The term under root takes into account for the valve inlet velocity (the so called “velocity of approach”). Except for wide open ball and butterfly valves, it can be neglected in the enthalpic balance and taken as unity.

Since the C_V in Re_v equation is the flow coefficient calculated by assuming turbulent flow conditions, the actual value of C_V must be found by an iterative calculation.

5.10 Valve style modifier F_d

The F_d factor is the valve style modifier and takes into account for the geometry of trim in the throttling section. It can be determined by tests or, in first approximation, by means of its definition:

$$F_d = \frac{d_H}{d_o}$$

where:

- d_H is the hydraulic diameter of a single flow passage [mm];
- d_o is equivalent circular flow passage diameter [mm].

In detail, the hydraulic diameter is defined as four times the “hydraulic radius” of the flow passage at the actual valve stroke:

$$d_H = \frac{4 \cdot A}{P_w}$$

while the equivalent circular flow passage diameter is:

$$d_o = \sqrt{\frac{4 \cdot A}{\pi}}$$

where:

- A is the flow passage area at the actual valve stroke [mm²];
- P_w is the wetted perimeter of flow passage (it is equal to 1 for circular holes) [mm].

The simpler is the geometry of flow pattern in the throttling section the more reliable is the theoretical evaluation of F_d factor with the above formulas.

Knowing the value of the F_d factor is especially important in the following cases:

- **micro-flow valves:** where it is frequent the presence of laminar flow, and then the use of the F_R factor. In these valves, characterised by flute, needle or other type of plug, it is important to keep in mind that the theoretical evaluation of F_d factor is highly dependent by the annular gap between plug and seat. In these cases, the theoretical evaluation of F_d factor is reliable only for flow coefficient C_V higher than 0.1.
- **low-noise valves:** the F_d factor defines, in particular formulations, the flow diameter and then the predominating frequency of the acoustic spectrum produced by the valve. Its knowledge is then very important the estimation of the noise produced by the valve during operation.

As an example, the valves with multi-drilled cage trims have a F_d factor equal to:

$$F_d = \frac{1}{\sqrt{N_o}}$$

where N_o is the number of drilled holes in parallel.

It follows that, higher is the value of N_o , smaller are the holes at same flow coefficient C_V and lower is the F_d factor, which means lower generated noise.

For more information about noise in control valves, refer to THINKTANK Technical Bulletin “Noise Manual”.

HANDBOOK FOR CONTROL VALVE SIZING – TECHNICAL BULLETIN 1-1

CONTROL VALVE DATA SHEET					Tag No.					
					Serial No.					
1	2	3	4	5	1	2	3	4	5	
SEL	ITEM	REV	MAIN	TERMS & DEFINITIONS	SEL	ITEM	REV	MAIN	TERMS & DEFINITIONS	
	1		PROCESS DATA RELEVANT FOR CONTROL SELECTION	Location		57		ACTUATOR	MFR _____ Model _____	
	2			Service			58			Pneumatic <input type="checkbox"/> diaphragm <input type="checkbox"/> piston <input type="checkbox"/>
	3			Haz. area class _____ IP Code _____			59			Style <input type="checkbox"/> sprg. return <input type="checkbox"/> double act. <input type="checkbox"/>
	4			Ambient temp. min. _____ max. _____			60			Size _____ eff area _____ cm ²
	5			Allowable sound pressure level _____ dB(A)			61			Travel/angle _____
	6			Upstr. pipe NPS/DN _____ SCH _____ t(mm) _____			62			Supply press. min. _____ max. _____ bar g
	7			Downstr. pipe NPS/DN _____ SCH _____ t(mm) _____			63			Bench range _____ bar g
	8			Pipe class _____ Material _____			64			Stroking time min _____ max _____ s frequency _____ /min
	9			Pipe insulation <input type="checkbox"/> thermal <input type="checkbox"/> acoustic			65			Air connection _____
	10			Design: Press. bar g _____ Temp. max min _____ °C			66			Other actuator <input type="checkbox"/> elect. <input type="checkbox"/> hydraulic <input type="checkbox"/> manual
	11			Pipe connection upstr. _____ downstr. _____			67			Act. force/torque min _____ max _____ unit
	12			Process fluid _____			68			manual override <input type="checkbox"/> no <input type="checkbox"/> mechanical <input type="checkbox"/> hydraulic
	13			Upstream cond. <input type="checkbox"/> liquid <input type="checkbox"/> vapour <input type="checkbox"/> gas <input type="checkbox"/> 2phase			69		limit stops <input type="checkbox"/> closed <input type="checkbox"/> % travel <input type="checkbox"/> open	
	14			Special fluid properties:			70		MFR _____ Model _____	
	15				Min. _____ Norm. _____ Max. _____ Unit _____		71		Input signal <input type="checkbox"/> pneum. <input type="checkbox"/> electric analog <input type="checkbox"/> digital	
	16			Flow rate _____			72		Valve open at _____ Valve closed at _____	
	17			Inlet press. P1 _____			73			
	18			Outlet press. P2 _____			74		Style <input type="checkbox"/> single act. <input type="checkbox"/> double act.	
	19			Temperature T1 _____			75		Characteristic <input type="checkbox"/> linear <input type="checkbox"/> eq% <input type="checkbox"/> modified	
	20			Inlet density ρ1 or M _____			76		Air connection _____ Electr. connection _____	
	21			Vapour pressure Pv _____			77		Accessories <input type="checkbox"/> bypass <input type="checkbox"/> gauges	
	22			Critical pressure Pc _____			78		Protection mode _____	
	23			Viscosity _____			79		Digital comm. <input type="checkbox"/> HART <input type="checkbox"/> FF <input type="checkbox"/> Profibus <input type="checkbox"/>	
	24			Specific heat ratio γ _____			80			
	25			Comp. fact. Z1 _____			81		MFR _____ Model _____	
	26			Gas/vapour mass fract. _____			82		Switch type <input type="checkbox"/> mech. <input type="checkbox"/> proximity <input type="checkbox"/>	
	27			Shutoff press. P1 _____ P2 _____ Unit _____			83		Switching pos. <input type="checkbox"/> closed <input type="checkbox"/> % travel <input type="checkbox"/> open	
	28			Air supply min. _____ max. _____ Unit _____			84		Switch acting <input type="checkbox"/> N.O. <input type="checkbox"/> N.C.	
	29			Power fail position <input type="checkbox"/> open <input type="checkbox"/> closed <input type="checkbox"/> hold			85		Protection mode _____	
	30			Signal fail position <input type="checkbox"/> open <input type="checkbox"/> closed <input type="checkbox"/> hold			86		Assembly <input type="checkbox"/> external <input type="checkbox"/> built-in	
	31		C/LpA	Calc. C <input type="checkbox"/> Kv <input type="checkbox"/> Cv _____		87		SOLENOID VALVE	MFR _____ Model _____	
	32			Valve <input type="checkbox"/> XT <input type="checkbox"/> FL _____			88			Valve type <input type="checkbox"/> 2 way <input type="checkbox"/> 3/2 way <input type="checkbox"/> 5/2 way
	33			Relative travel _____ %			89			De-energ.: control valve <input type="checkbox"/> open <input type="checkbox"/> closed <input type="checkbox"/> hold
	34			Predicted LpA _____ dB(A)			90			<input type="checkbox"/> digital operated
	35		VALVE BODY ASSEMBLY	MFR _____ Model _____		91		OTHERS	Air connection _____ Port size _____	
	36			Body type <input type="checkbox"/> straight <input type="checkbox"/> angle <input type="checkbox"/> 3-way			92			Electrical data _____ V _____ Hz _____ W
	37			Flow direction <input type="checkbox"/> FTO <input type="checkbox"/> FTC <input type="checkbox"/> manif. std.			93			Protection mode _____
	38			Pressure rating _____			94		SPECIAL REQUIREMENTS	<input type="checkbox"/> Air set MFR. _____ Model _____
	39			Nominal size _____			95			<input type="checkbox"/> with filter _____ <input type="checkbox"/> with gauge _____
	40			End conn. <input type="checkbox"/> flgd. <input type="checkbox"/> figless. <input type="checkbox"/> welded <input type="checkbox"/> thrd.			96			<input type="checkbox"/> I/P converter MFR. _____ Model _____
	41			Connection spec. _____			97			Input Signal _____ Output Signal _____
	42			End connections upstr. _____ downstr. _____			98			<input type="checkbox"/> Booster MFR. _____ Model _____
	43			Bonnet style <input type="checkbox"/> standard <input type="checkbox"/> extension <input type="checkbox"/> bellows			99			<input type="checkbox"/> Pos. feedback <input type="checkbox"/> electr. <input type="checkbox"/> pneum. <input type="checkbox"/> digital
	44						100			<input type="checkbox"/> Lockup relays MFR. _____ Model _____
	45			Body/bonnet mat. _____			101			<input type="checkbox"/> Air trip valve MFR. _____ Model _____
	46			Trim Type _____			102			Air tubing _____ Mat. _____
	47		Characteristic <input type="checkbox"/> linear <input type="checkbox"/> eq. percent <input type="checkbox"/>			103		Air fittings _____ Mat. _____		
	48		Closure member mat. _____ stem mat. _____			104		Test certificate(s) <input type="checkbox"/> chem. and mech. test		
	49		Guide(cage) mat. _____ seat mat. _____			105		NDE Examination <input type="checkbox"/> surface <input type="checkbox"/> volume		
	50		Rated C <input type="checkbox"/> Kv <input type="checkbox"/> Cv _____ Inh. rangeability _____ :1			106		Acceptance Std./Criteria _____		
	51		Seat style <input type="checkbox"/> metallic <input type="checkbox"/> soft seated			107		Parts to be tested <input type="checkbox"/> body/bonnet		
	52		Trim coating/treatment _____			108		<input type="checkbox"/> bolts/nuts <input type="checkbox"/> trim		
	53		Breakaway force/torque _____ max. allowed _____			109				
	54		Leakage specification IEC 60534-4 Class: _____			110				
	55		Packing <input type="checkbox"/> adjustable <input type="checkbox"/> self adj. Mat. _____			111		Dig. Communication: _____		
	56		Steam jacket: <input type="checkbox"/> no <input type="checkbox"/> yes; PN _____ Mat. _____			112		Software drivers: _____		
Remarks:										
					Project _____				Dwg. ref. No. _____	
					Plant _____				Mt. req. No. _____	
Rev.	Date	Name	Date	Name	P.O. No.				Item No. _____ Qty _____	

Figure 16 – Control valve datasheet (source: IEC 60534-7).

Optimal Fluid Solutions



Cell: +86-18958138289

WhatsApp: +86-18516569221

E-mail: marketing@cncontrolvalve.com